

Weldlok™ 10, 20, 32 & 43 weldable clips

SUGGESTED WELD

- The lower component of the GANTREX Weldlok Series clip is welded to the support structure. The weld size in the V-shaped recess on the side facing the rail, must not exceed 3/16". This will avoid any interference with the locating lug on the upper component. Welds on the back and sides of the clip may be as large as required to accommodate the imposed side thrust and to meet governing welding code requirements.
- The following are welds suggested by GANTREX. The actual weld size (which is dictated by design thrust) and the welding procedure should be specified by the designer.

WELDLOK 10-20

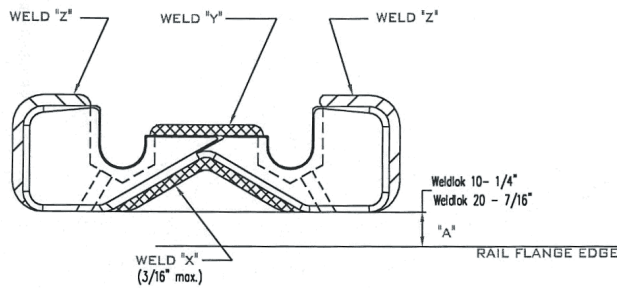

Note: For applications where soleplate and attached clips are to be hot-dip-galvanized: Weld "Z" must leave the back drain holes open for draining the zinc from the clip bolt cavity.

WELDLOK 32-43

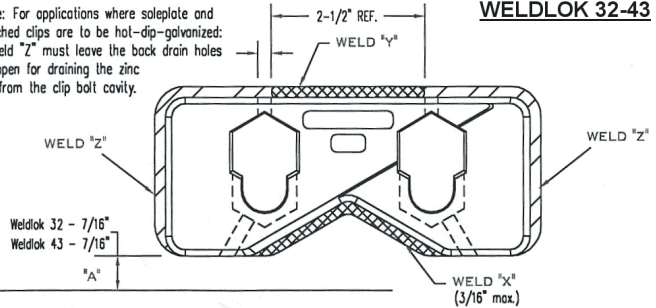

WELD	SIZE	SIDE THRUST CAPACITY (Lbs/Clip)			
		WELDLOK 10	WELDLOK 20	WELDLOK 32	WELDLOK 43
X + Y	3/16"	10,000	7,500	10,200	10,200
X + Y + Z	3/16"	13,000	12,000	22,000	22,000

- WELDLOK 10 SERIES - The maximum side thrust capacity of 17,000* lbs can be obtained by increasing (Weld "Y" & "Z") to 1/4".
- WELDLOK 20 SERIES - The maximum side thrust capacity of 20,000* lbs can be obtained by increasing (Weld "Y" & "Z") to 3/8".
- WELDLOK 32 SERIES- The maximum side thrust capacity of 32,000* lbs can be obtained by increasing (Weld "Y" & "Z") to 1/4".
- WELDLOK 43 SERIES - The maximum side thrust capacity of 43,000* lbs can be obtained by increasing (Weld "Y" & "Z") to 3/8".

NOTE: Side thrust capacities shown above are based on allowable weld stress of 15,000 psi for up to 100,000 full load cycles. AISC requires a reduction for up to 500,000 cycles and a further reduction for up to 2,000,000 cycles.

SUGGESTED WELD AND INSTALLATION INSTRUCTIONS WELDLOK™ 10, 20, 32 & 43 RAIL CLIPS

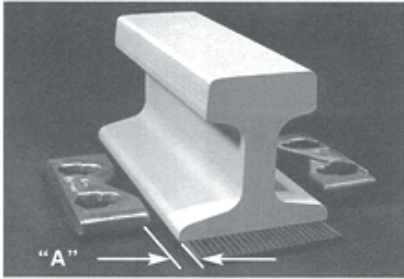

1. Position lower component with gap "A" as shown and tack weld in place.

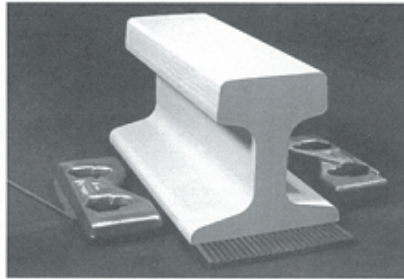

2. Weld as shown on the fabrication drawing, ensuring that the clip lower does not lift.

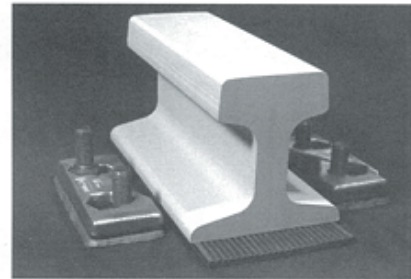

3. After installing bolts, make sure they are pushed as far forward as possible.

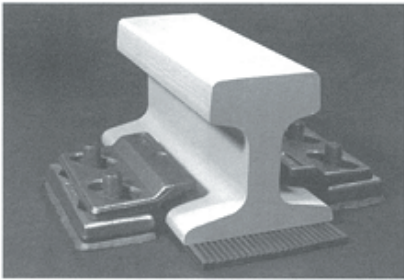

4. Install upper component.

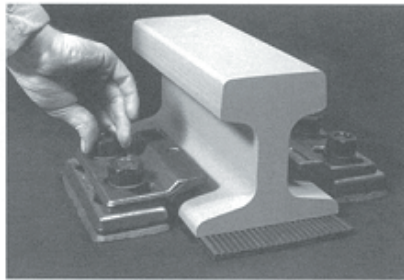

5. Install washers and nuts finger tight.

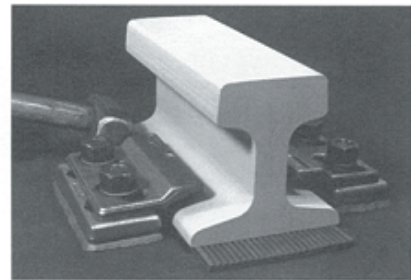

6. Adjust upper component to ensure tight contact with rail flange edge.

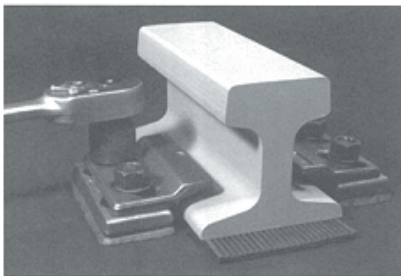

7. Torque nuts as shown in table.

CLIP	BOLT	TORQUE ft lbs	"A" DIMENSION (ins)
WELDLOK 10	1/2" Dia Gr 5	75	1/4"
WELDLOK 20	3/4" Dia Gr 5	250	7/16"
WELDLOK 32	M20 HHCS x 35	180	7/16"
WELDLOK 43	3/4" Dia Gr 5	250	7/16"

- The correct bolt assembly consists of a Grade 5 hex head capscrew with A325 structural nut and washer.
- The correct bolt assembly for the Weldlok 32 consists of a modified M20 HHCS x 35mm screw with a 20 mm jam nut and 3/4" hardened structural washer.
- Weld rod: any low hydrogen rod suitable for use with structural steel may be used. Typical designations include E7018.
- Clips should be installed in opposing pairs. They should NEVER be staggered.
- For new installations the lower component should be welded in the fabrication facility (steps 1 and 2).
- Welding should be completed prior to pad installation, as excessive heat could damage the pad.
- Painting the lower component may reduce side thrust capacity.

It is imperative that the clips be adjusted to ensure ZERO lateral rail float as shown in Figure 6. Improper adjustment will cause pad failure. Verification of the required hardware torque and clip upper adjustment should be performed within the first three months of running operation.

For clarification on any of the above or for more comprehensive suggestions on repair or reraill projects, consult GANTREX.

GANTREX reserves the right to discontinue or change specifications at any time without prior notice and without incurring any obligation whatsoever.



TOLL FREE: 800 2 GANTREX (800) 242-6873

Web site: www.gantrex.com • Email: sales@gantrex.com

© GANTREX, 2008
PRINTED in U.S.A.

Rev. 01/08